



SARA-R4 series

LTE Cat M1 / NB1 and EGPRS modules

Data sheet



Abstract

Technical data sheet describing the size-optimized SARA-R4 series LTE Cat M1 / NB1 and EGPRS cellular modules. The modules are a complete and cost efficient solution offering multi band data transmissions for Low Power Wide Area solutions in a compact form factor.

Document information

Title	SARA-R4 series	
Subtitle	LTE Cat M1/NB1 and EGPRS modules	
Document type	Data sheet	
Document number	UBX-16024152	
Revision and date	R18	20-Dec-2019
Disclosure restriction		

Product status	Corresponding content status	
Functional sample	Draft	For functional testing. Revised and supplementary data will be published later.
In development / Prototype	Objective specification	Target values. Revised and supplementary data will be published later.
Engineering sample	Advance information	Data based on early testing. Revised and supplementary data will be published later.
Initial production	Early production information	Data from product verification. Revised and supplementary data may be published later.
Mass production / End of life	Production information	Document contains the final product specification.

This document applies to the following products:

Product name	Type number	Modem version	Application version	PCN reference	Product status
SARA-R404M	SARA-R404M-00B-00	K0.0.00.00.07.06		UBX-17047084	Obsolete
	SARA-R404M-00B-01	K0.0.00.00.07.08		UBX-18055331	Obsolete
SARA-R410M	SARA-R410M-01B-00	L0.0.00.00.02.03		UBX-18059854	Obsolete
	SARA-R410M-02B-00	L0.0.00.00.05.06	A02.00	UBX-18010263	Obsolete
		L0.0.00.00.05.06	A02.01	UBX-18070443	Obsolete
	SARA-R410M-02B-01	L0.0.00.00.05.08	A02.04	UBX-19041392	Mass production
	SARA-R410M-52B-00	L0.0.00.00.06.05	A02.06	UBX-18045915	Obsolete
	SARA-R410M-52B-01	L0.0.00.00.06.08	A02.11	UBX-19041392	Mass production
	SARA-R410M-63B-00	L0.08.12	A.01.09	UBX-19047631	Engineering sample
	SARA-R410M-73B-00	L0.08.08	A01.06	UBX-19040180	Prototype
SARA-R412M	SARA-R412M-02B-00	M0.09.00	A02.11	UBX-19004091	Obsolete
	SARA-R412M-02B-01	M0.10.00	A02.14	UBX-19016568	Initial production
SARA-N410	SARA-N410-02B-00	L0.0.00.00.07.07	A02.09	UBX-19035715	Obsolete

u-blox or third parties may hold intellectual property rights in the products, names, logos and designs included in this document. Copying, reproduction, modification or disclosure to third parties of this document or any part thereof is only permitted with the express written permission of u-blox.

The information contained herein is provided "as is" and u-blox assumes no liability for its use. No warranty, either express or implied, is given, including but not limited to, with respect to the accuracy, correctness, reliability and fitness for a particular purpose of the information. This document may be revised by u-blox at any time without notice. For the most recent documents, visit www.u-blox.com.

Copyright © u-blox AG.

Contents

Document information	2
Contents	3
1 Functional description	5
1.1 Overview	5
1.2 Product features	5
1.3 Block diagram	6
1.4 Product description	7
1.5 AT command support	9
1.6 Supported features	9
2 Interfaces	11
2.1 Power management	11
2.1.1 Module supply input (VCC)	11
2.1.2 Generic digital interfaces supply output (V_INT)	11
2.2 Antenna interface	11
2.2.1 Antenna RF interface (ANT)	11
2.2.2 Antenna detection (ANT_DET)	11
2.3 System functions	11
2.3.1 Module power-on	11
2.3.2 Module power-off	12
2.3.3 Module reset	12
2.4 SIM	12
2.4.1 SIM interface	12
2.4.2 SIM detection	12
2.5 Serial communication	12
2.5.1 UART interface	13
2.5.2 USB interface	13
2.5.3 SPI interface	14
2.5.4 SDIO interface	14
2.5.5 DDC (I2C) interface	14
2.6 Audio	15
2.7 GPIO	15
3 Pin definition	16
3.1 Pin assignment	16
4 Electrical specifications	20
4.1 Absolute maximum rating	20
4.1.1 Maximum ESD	20
4.2 Operating conditions	21
4.2.1 Operating temperature range	21
4.2.2 Thermal parameters	21
4.2.3 Supply/power pins	22

4.2.4	Current consumption.....	23
4.2.5	LTE RF characteristics	24
4.2.6	2G RF characteristics	26
4.2.7	ANT_DET pin characteristics.....	26
4.2.8	PWR_ON pin.....	27
4.2.9	RESET_N pin.....	27
4.2.10	SIM pins	27
4.2.11	USB pins	28
4.2.12	Generic digital interfaces pins	28
4.2.13	DDC (I2C) pins.....	28
4.3	Parameters for ATEX applications.....	29
5	Mechanical specifications	30
6	Qualification and approvals.....	31
6.1	Approvals.....	31
6.2	Reliability tests.....	33
7	Product handling & soldering.....	34
7.1	Packaging	34
7.1.1	Reels	34
7.1.2	Tapes.....	35
7.2	Moisture Sensitivity Levels.....	36
7.3	Reflow soldering	36
7.4	ESD precautions.....	36
8	Labeling and ordering information	37
8.1	Product labeling.....	37
8.2	Explanation of codes	37
8.3	Ordering information.....	38
Appendix	39
A	Glossary	39
Related documents	41
Revision history	42
Contact	43

1 Functional description

1.1 Overview

SARA-R4 series modules are an LTE Cat M1, LTE Cat NB1 and EGPRS multi-mode solution in the miniature SARA LGA form factor (26.0 x 16.0 mm, 96-pin). They allow an easy integration into compact designs and a seamless drop-in migration from other u-blox cellular module families.

SARA-R4 series modules provide software-based multi-band configurability enabling international multi-regional coverage in LTE Cat M1 / NB1 and (E)GPRS radio access technologies.

SARA-R4 series modules offer data communications up to 375 kb/s over an extended operating temperature range of -40 °C to +85 °C, with low power consumption, and with coverage enhancement for deeper range into buildings and basements (and underground with NB1).

With many interface options and an integrated IP stack, SARA-R4 series modules are the optimal choice for LPWA applications with low to medium data throughput rates, as well as devices that require long battery lifetimes, such as used in smart metering, smart lighting, telematics, asset tracking, remote monitoring, alarm panels, and connected health.

Customers can future-proof their solutions by means of Over-The-Air firmware updates, thanks to the uFOTA client/server solution that utilizes LWM2M, a light and compact protocol ideal for IoT.

SARA-R4 series modules will also support VoLTE over Cat M1. The flexibility extends further through dynamic mode selection as M1-only/preferred or NB1-only/preferred.

1.2 Product features

Product variant	Region	Bands	Positioning	Interfaces	Audio	Features	Grade
		3GPP Release Baseline 3GPP LTE category LTE FDD bands (E)GPRS 4-band	GNSS via modem AssistNow software CellLocate®	UART USB 2.0 SPI SDIO DDC (I2C) GPIOs	Analog audio Digital audio	Power Saving Mode eDRX Antenna supervisor Embedded TCP/UDP Embedded HTTP, FTP Dual stack IPv4/IPv6 FOTA	Standard Professional Automotive
SARA-R404M-00B	USA	13 M1 13		• • •		• • • • • • •	•
SARA-R410M-01B	North America	13 M1 2,4 5,12		• • •		• • • • • • •	•
SARA-R410M-02B	Multi Region	13 M1 NB1 *	• • ○	• • •		• • • • • • •	•
SARA-R410M-52B	North America	13 M1 2,4,5 12,13	• •	• • •		• • • • • • •	•
SARA-R410M-63B	Japan	13 M1 1,8,19	• • •	• • •		• • • • • • •	•
SARA-R410M-73B	Korea	13 M1 3,5,26	• • •	• • •		• • • • • • •	•
SARA-R412M-02B	Multi Region	13 M1 NB1 *	• • ○	• • •		• • • • • • •	•
SARA-N410-02B	Multi Region	13 NB1 *	• •	• • •		• • • • • • •	•

* = Bands may include 1, 2, 3, 4, 5, 8, 12, 13, 18, 19, 20, 25, 26, 28 • = supported by all FW versions ○ = supported by future FW versions

Table 1: SARA-R4 series main features summary ¹

¹ See Table 29 for the model / marketing name of each product variant, as identified by various certification bodies.

1.3 Block diagram

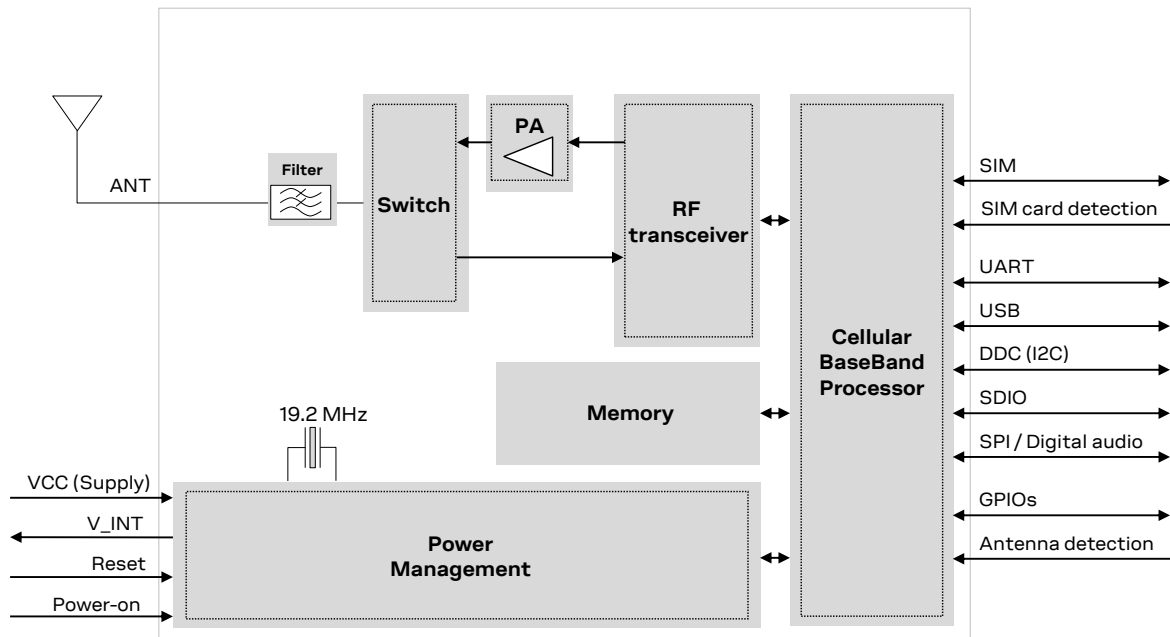

Figure 1: SARA-R4 series block diagram

SARA-R404M-00B and SARA-R410M-01B modules, i.e. the “00” and “01” product versions of the SARA-R4 series modules, do not support the following interfaces, which should be left unconnected and should not be driven by external devices:

- DDC (I2C) interface
- SDIO interface
- SPI interface
- Digital audio interface

SARA-R410M-02B, SARA-R410M-52B, SARA-R410M-63B, SARA-R410M-73B, SARA-R412M-02B, SARA-N410-02B modules, i.e. the “02”, “52”, “63”, “73” product versions of the SARA-R4 series modules, do not support the following interfaces, which should be left unconnected and should not be driven by external devices:

- SDIO interface
- SPI interface
- Digital audio interface

1.4 Product description

SARA-R4 series modules include the following variants / product versions:

- SARA-R404M LTE Cat M1 module,
mainly designed for operation in LTE band 13
- SARA-R410M-01B LTE Cat M1 module,
mainly designed for operation in LTE bands 2, 4, 5, 12
- SARA-R410M-02B LTE Cat M1 / NB1 module,
mainly designed for operation in LTE bands 2, 3, 4, 5, 8, 12, 13, 20, 25, 28
- SARA-R410M-52B LTE Cat M1 module,
mainly designed for operation in LTE bands 2, 4, 5, 12, 13
- SARA-R410M-63B LTE Cat M1 module,
mainly designed for operation in LTE bands 1, 8, 19
- SARA-R410M-73B LTE Cat M1 module,
mainly designed for operation in LTE bands 3, 5, 26
- SARA-R412M-02B LTE Cat M1 / NB1 and 2G module,
mainly designed for operation in LTE bands 2, 3, 4, 5, 8, 12, 13, 20 and 2G Quad-band
- SARA-N410-02B LTE Cat NB1 module,
mainly designed for operation in LTE bands 2, 3, 4, 5, 8, 12, 13, 28

[Table 2](#) summarizes cellular radio access technologies characteristics and features supported by the SARA-R4 series modules.

 See [Table 28](#) for the detailed list of RATs and bands included in each certification approval of the SARA-R4 series modules product versions.

Item	SARA-R404M	SARA-R410M	SARA-R412M	SARA-N410
Protocol stack	3GPP Release 13	3GPP Release 13	3GPP Release 13	3GPP Release 13
RAT	LTE Cat M1 Half-Duplex	LTE Cat M1 Half-Duplex LTE Cat NB1 Half-Duplex ^{2,4,5,7}	LTE Cat M1 Half-Duplex LTE Cat NB1 Half-Duplex 2G GPRS / EGPRS	LTE Cat NB1 Half-Duplex
LTE FDD bands	Band 13 (750 MHz)	Band 1 (2100 MHz) ^{2,5} Band 2 (1900 MHz) ⁷ Band 3 (1800 MHz) ^{2,5} Band 4 (1700 MHz) ⁷ Band 5 (850 MHz) Band 8 (900 MHz) ^{2,5} Band 12 (700 MHz) ⁷ Band 13 (750 MHz) ^{2,7} Band 18 (850 MHz) ^{2,4,5,7} Band 19 (850 MHz) ^{2,4,5} Band 20 (800 MHz) ^{2,5,7} Band 25 (1900 MHz) ^{2,3,4,5,6,7} Band 26 (850 MHz) ^{2,4,5} Band 28 (700 MHz) ^{2,5,7}	Band 2 (1900 MHz) Band 3 (1800 MHz) Band 4 (1700 MHz) Band 5 (850 MHz) Band 8 (900 MHz) Band 12 (700 MHz) Band 13 (750 MHz) Band 20 (800 MHz) Band 26 (850 MHz) ⁸ Band 28 (700 MHz) ⁸	Band 2 (1900 MHz) Band 3 (1800 MHz) Band 4 (1700 MHz) Band 5 (850 MHz) Band 8 (900 MHz) Band 12 (700 MHz) Band 13 (750 MHz) Band 20 (800 MHz) Band 28 (700 MHz)
2G bands			GSM 850 MHz E-GSM 900 MHz DCS 1800 MHz PCS 1900 MHz	
Power class	LTE Cat M1: Class 3 (23 dBm)	LTE Cat M1 / NB1 ⁹ : Class 3 (23 dBm)	LTE category M1 / NB1: Class 3 (23 dBm) 2G GSMK: Class 4 (33 dBm) for GSM/E-GSM bands Class 1 (30 dBm) for DCS/PCS bands 2G 8-PSK: Class E2 (27 dBm) for GSM/E-GSM bands Class E2 (26 dBm) for DCS/PCS bands	LTE category NB1: Class 3 (23 dBm)
Data rate	LTE category M1: up to 375 kb/s UL up to 300 kb/s DL	LTE category M1: up to 375 kb/s UL up to 300 kb/s DL LTE category NB1 ⁹ : up to 62.5 kb/s UL up to 27.2 kb/s DL	LTE category M1: up to 375 kb/s UL up to 300 kb/s DL LTE category NB1: up to 62.5 kb/s UL up to 27.2 kb/s DL GPRS multi-slot class 33 ¹⁰ : Up to 85.6 kb/s UL Up to 107 kb/s DL EGPRS multi-slot class 33 ¹⁰ : Up to 236.8 kb/s UL Up to 296.0 kb/s DL	LTE category NB1: up to 62.5 kb/s UL up to 27.2 kb/s DL

Table 2: SARA-R4 series LTE Cat M1, LTE Cat NB1, EGPRS and GPRS characteristics

² Not supported by the SARA-R410M-01B product version.

³ Not supported by the SARA-R410M-02B-00 product version.

⁴ Not supported by the SARA-R410M-52B-00 product version.

⁵ Not supported by the SARA-R410M-52B-01 product version.

⁶ Not supported in LTE Cat NB1 by the SARA-R410M-02B-01 product version.

⁷ Not supported by the SARA-R410M-63B and SARA-R410M-73B product version.

⁸ Not supported by the SARA-R412M-02B-00 product version.

⁹ LTE Cat NB1 not supported by SARA-R410M-01B, SARA-R410M-52B, SARA-R410M-63B, SARA-R410M-73B product versions.

¹⁰ GPRS/EGPRS multi-slot class 33 implies a maximum of 5 slots in Down-Link and 4 slots in Up-Link with 6 slots in total.

1.5 AT command support

The SARA-R4 series modules support AT commands according to the 3GPP standards TS 27.007 [4], TS 27.005 [6], TS 27.010 [7], and the u-blox AT command extension.

 For the complete list of all supported AT commands and their syntax, see the SARA-R4 series AT commands manual [1].

1.6 Supported features

Table 3 lists some of the main features supported by SARA-R4 series modules. For more details, see the SARA-R4 series system integration manual [2] and the SARA-R4 series AT commands manual [1].

Feature	Description
Network indication	GPIO configured to indicate the network status: registered home network, registered roaming, data call enabled, no service. The feature can be enabled through the +UGPIOC AT command.
Antenna detection	The ANT_DET pin provides antenna presence detection capability, evaluating the resistance from the ANT pin to GND by means of an external antenna detection circuit implemented on the application board. The antenna supervisor (i.e. antenna detection) feature can be enabled through the +UANTR AT command.
Embedded TCP and UDP stack	Embedded TCP/IP and UDP/IP stack including direct link mode for TCP and UDP sockets. Sockets can be set in Direct Link mode to establish a transparent end-to-end communication with an already connected TCP or UDP socket via the serial interface.
FTP	File Transfer Protocol functionality is supported via AT commands.
HTTP	Hyper-Text Transfer Protocol functionality is supported via AT commands.
Embedded SSL/TLS ¹¹	With the support of X.509 certificates, embedded SSL/TLS provides server and client authentication, data encryption, data signature and enables TCP/IP applications to communicate over a secured and trusted connection. The feature can be configured and enabled by the +USECMNG and +USECPRF AT commands.
Device and data security ¹²	Device security: authentication, updates Data security: PSK, E2E encryption, local encryption For more details, see the security suite application note [4]
MQTT ¹³	Message Queuing Telemetry Transport is an ISO standard publish-subscribe messaging protocol designed for lightweight M2M communications over TCP. MQTT allows clients to communicate one-to-one, one-to-many and many-to-one over a long-lived outgoing TCP connection.
BIP ¹³	Bearer Independent Protocol for Over-the-Air SIM provisioning.
Dual stack IPv4/IPv6	Capability to move between IPv4 and dual stack network infrastructures. IPv4 and IPv6 addresses can be used.
MNO profiles ¹³	Mobile network operator profiles provide with a powerful and flexible method to configure the SARA-R4 series modules to seamlessly work with the selected mobile network operator. Using the MNO profiles the device is dynamically configured to use the proper bands, RATs, power saving parameters, e-DRX parameters and the protocol stack settings needed to operate on the selected network in full compliance with operator requirements. Use the +UMNOPROF AT command to select a profile for the network operator.
Firmware update Over AT commands (FOAT)	Firmware module update over AT command interface. The feature can be enabled and configured through the +UFWUPD AT command.
Firmware update Over The Air (uFOTA)	u-blox firmware module update over the LTE air interface client/server solution using LWM2M.

¹¹ Not supported by "00" product version

¹² Not supported by "00", "01", "02" and "52" product versions

¹³ Not supported by "00" and "01" product versions

Feature	Description
GNSS via modem ¹⁴	Full access to u-blox positioning chips and modules is available through DDC (I2C) interface. This means that from any host processor, a single serial port can control the SARA-R4 series cellular module and the u-blox positioning chip or module.
CellLocate ¹⁵	Enables the estimation of device position based on the parameters of the mobile network cells visible to the specific device based on the CellLocate® database. CellLocate® is available via a set of AT commands for CellLocate® service configuration and position request.
Power Saving Mode (PSM)	The Power Saving Mode (PSM) feature, defined in 3GPP Rel.13, allows further reduction of the module current consumption maximizing the amount of time a device can remain in PSM low power deep sleep mode during periods of data inactivity. It can be activated and configured by the +CPSMS AT command.
e-I-DRX ¹⁶	Extended Idle mode DRX, based on 3GPP Rel.13, reduces the amount of signaling overhead decreasing the frequency of scheduled measurements and/or transmissions performed by the module in idle mode. This in turn leads to a reduction in the module power consumption while maintaining a perpetual connection with the base station.
Coverage Enhancements Mode A	Coverage Enhancements (CE) Mode A, introduced in 3GPP Rel.13, is used to improve cell signal penetration.
Coverage Enhancements Mode B ¹⁷	Coverage Enhancements (CE) Mode B, introduced in 3GPP Rel.13, is used to further improve cell signal penetration.
Connected Mode Mobility ¹⁸	LTE Cat M1 Connected Mode Mobility (CMM) with CE Mode A
Release Assistance Indicator ¹⁸	The 3GPP Release Assistance feature allows the module to request for the RRC connection to be dropped as soon as the message has been received by the network. This feature allows a reduction in the module power consumption.
LWM2M with dynamically loaded objects ¹⁸	Method allowing dynamically loaded run time objects for customers to configure u-blox modules to define necessary objects, create instances of those objects as appropriate, manage module LWM2M protocol stack to interact with the LWM2M server.

Table 3: Some of the main features supported by SARA-R4 series modules

 u-blox is extremely mindful of user privacy. When a position is sent to the CellLocate® server, u-blox is unable to track the SIM used or the specific device.

¹⁴ Not supported by “00” and “01” product versions

¹⁵ Not supported by “00”, “01”, “02” and “52” product versions

¹⁶ The feature is disabled on “00” and “01” product versions due to network readiness

¹⁷ Not supported by “00”, “01”, “02”, “52”, “63” and “73” product versions

¹⁸ Not supported by “00”, “01”, “02” and “52” product versions

2 Interfaces

2.1 Power management

2.1.1 Module supply input (VCC)

SARA-R4 series modules must be supplied through the **VCC** pins by a DC power supply. Voltage must be stable, because during operation the current drawn from **VCC** may vary significantly, based on the power consumption profile of the LTE Cat M1, LTE Cat NB1 and the 2G radio access technologies (described in the SARA-R4 series system integration manual [2]).

SARA-R412M modules provide separate supply inputs over the three **VCC** pins:

- **VCC** pins #52 and #53 represent the supply input for the internal RF Power Amplifier, demanding most of the total current drawn of the module when RF transmission is enabled during a call
- **VCC** pin #51 represents the supply input for the internal baseband Power Management Unit, demanding minor part of the total current drawn of the module when RF transmission is enabled during a call

The three **VCC** pins of SARA-R404M, SARA-R410M and SARA-N410 modules are internally connected to both the internal Power Amplifier and the internal baseband Power Management Unit.

It is important that the system power supply circuit is able to withstand the maximum pulse current during a transmit burst at maximum power level (see Table 12).

2.1.2 Generic digital interfaces supply output (V_INT)

SARA-R4 series modules provide a 1.8 V supply rail output on the **V_INT** pin, which is internally generated when the module is switched on. The same voltage domain is used internally to supply the generic digital interfaces of the module. The **V_INT** supply output can be used in place of an external discrete regulator.

2.2 Antenna interface

2.2.1 Antenna RF interface (ANT)

The **ANT** pin represents the RF antenna interface of the module, with a characteristic impedance of 50 Ω.

2.2.2 Antenna detection (ANT_DET)

The **ANT_DET** pin is an Analog to Digital Converter (ADC) input with a current source provided by SARA-R4 series modules to sense the antenna presence (as an optional feature). It evaluates the resistance from the **ANT** pin to GND by means of an external antenna detection circuit implemented on the application board (for more details, see the u-blox SARA-R4 series system integration manual [2] and the SARA-R4 series AT commands manual [1]).

2.3 System functions

2.3.1 Module power-on

SARA-R4 series can be switched on using the following procedure:

- Low level on the **PWR_ON** pin, which is normally set high by an internal pull-up, for a valid time period when the applied **VCC** voltage is within the valid operating range (see sections 4.2.3 and 4.2.8). The **PWR_ON** line has to be driven by open drain, open collector or contact switch.

2.3.2 Module power-off

SARA-R4 series can be properly switched off, with storage of the current parameter settings and a clean network detach, in one of these ways:

- AT+CPWROFF command (see the SARA-R4 series AT commands manual [1])
- Low pulse on the **PWR_ON** pin for a valid time period (see section 4.2.8)

An abrupt shutdown occurs on SARA-R4 series modules, without storage of the current parameter settings and without a clean network detach, when:

- the **VCC** supply drops below the extended operating range minimum limit
- a low level is applied on the **RESET_N** pin, which is normally set high by an internal pull-up, for a valid time period (see section 4.2.9). **RESET_N** line has to be driven by open drain, open collector or contact switch.

2.3.3 Module reset

SARA-R4 series modules can be reset (re-booted) by:

- AT+CFUN command (see the SARA-R4 series AT commands manual [1]). This causes an “internal” or “software” reset of the module. The current parameter settings are saved in the module’s non-volatile memory and a clean network detach is performed.

2.4 SIM

2.4.1 SIM interface

A SIM card interface is provided on **VSIM**, **SIM_IO**, **SIM_CLK**, **SIM_RST** pins: the high-speed SIM/ME interface is implemented as well as the automatic detection of the required SIM supporting voltage.

Both 1.8 V and 3 V SIM types are supported (1.8 V and 3 V). Activation and deactivation with an automatic voltage switch from 1.8 V to 3 V is implemented according to the ISO-IEC 7816-3 specifications. The SIM driver supports the PPS procedure for baud-rate selection, according to the values proposed by the SIM card/chip.

2.4.2 SIM detection

The **GPIO5** pin of SARA-R4 series modules is a 1.8 V digital input which can be configured as an external interrupt to detect the SIM card presence, as intended to be properly connected to the mechanical switch of an external SIM card holder. For more details, see the SARA-R4 series system integration manual [2] and the SARA-R4 series AT commands manual [1].

2.5 Serial communication

The SARA-R4 series provides the following serial communication interfaces:

- UART interface: asynchronous serial interface available for the communication with a DTE host application processor (AT commands, data communication, FW update by means of FOAT)
- USB interface: High-Speed USB 2.0 compliant interface available for communications with a USB host application processor (AT commands, data communication, FW update by means of the FOAT feature), for FW update by means of the u-blox tool and for diagnostics
- SPI interface: Serial Peripheral Interface available for communications with an external compatible device
- SDIO interface: Secure Digital Input Output interface available for communications with a compatible device
- DDC interface: I²C bus compatible interface available for communications with external I²C devices

2.5.1 UART interface

SARA-R4 series modules include a 9-wire unbalanced asynchronous serial interface (UART) for communication with an application host processor (AT commands and data communication).

 The UART is available only if the USB is not enabled as AT command / data communication interface: UART and USB cannot be concurrently used for this purpose.

UART features are:

- Complete serial port with RS-232 functionality conforming to ITU-T V.24 recommendation [10], with CMOS compatible signal levels (0 V for low data bit or ON state and 1.8 V for high data bit or OFF state)
- Data lines (**RXD** as output, **TXD** as input), hardware flow control lines (**CTS** as output, **RTS** as input), modem status and control lines (**DTR** as input, **DSR** as output, **DCD** as output, **RI** as output) are provided
- The default baud rate is 115'200 b/s
- The default frame format is 8N1 (8 data bits, no parity, 1 stop bit)

 Hardware flow control is not supported by the “00”, “01” and SARA-R410M-02B product versions, but the **RTS** input line needs to be set low (= ON state) to communicate over the UART interface on the “00” and “01” product versions.

The UART serial interface can be conveniently configured through AT commands. For more details, see the SARA-R4 series AT commands manual [1] and the SARA-R4 series system integration manual [2].

2.5.1.1 Multiplexer protocol

SARA-R4 series modules include multiplexer functionality as per 3GPP TS 27.010 [7] on the UART physical link.

This is a data link protocol which uses HDLC-like framing and operates between the module (DCE) and the application processor (DTE), allowing a number of simultaneous sessions over the physical link (UART).

The following virtual channels are defined:



- Channel 0: for multiplexer control
- Channel 1: for all AT commands, and non-Dial Up Network (non-DUN) data connections. UDP, TCP data socket / data call connections through relevant AT commands.
- Channel 2: for Dial Up Network (DUN) data connection. It requires the host to have and use its own TCP/IP stack. The DUN can be initiated on the modem side or terminal/host side.
- Channel 3: for u-blox GNSS data tunneling (not supported by the “00” and “01” product versions).

2.5.2 USB interface

SARA-R4 series modules include a high-speed USB 2.0 compliant interface with a maximum 480 Mb/s data rate according to the USB 2.0 specification [11] representing the main interface for transferring high speed data with a host application processor. The module itself acts as a USB device and can be connected to any USB host equipped with compatible drivers.

The USB is the most suitable interface for transferring high speed data between SARA-R4 series and a host processor, available for AT commands, data communication, FW upgrade by means of the FOAT feature, FW upgrade by means of the u-blox dedicated tool and for diagnostic purposes.

The **USB_D+** / **USB_D-** lines carry the USB data and signaling, while the **VUSB_DET** pin represents the input to enable the USB interface by applying an external valid USB VBUS voltage (5.0 V typical).

-  The USB interface is available as an AT command / data communication interface only if an external valid USB VBUS voltage (5.0 V typical) is applied at the **VUSB_DET** input of the module since the switch-on of the module, and then held during normal operations. In this case, the UART will not be available.
-  If the USB interface is enabled, the module does not enter the low power deep sleep mode: the external USB VBUS voltage needs to be removed from the **VUSB_DET** input of the module to let it enter the Power Saving Mode defined in 3GPP Rel.13.

SARA-R4 series modules provide by default a set of two USB functions:

- AT commands and data communication
- Diagnostic log

For more details regarding USB configurations / capabilities, see the SARA-R4 series system integration manual [\[2\]](#).

2.5.3 SPI interface

-  The SPI interface is not supported by the “00”, “01”, “02”, “52”, “63” and “73” product versions.

SARA-R4 series modules include a Serial Peripheral Interface for communications with compatible external device.

The SPI interface can be made available as an alternative function, in a mutually exclusive way, over the digital audio interface pins (**I2S_WA** / **SPI_MOSI**, **I2S_RXD** / **SPI_MISO**, **I2S_CLK** / **SPI_CLK**, **I2S_TXD** / **SPI_CS**).

2.5.4 SDIO interface

-  The SDIO interface is not supported by “00”, “01”, “02”, “52”, “63” and “73” product versions.

SARA-R4 series modules include a 4-bit Secure Digital Input Output interface (**SDIO_D0**, **SDIO_D1**, **SDIO_D2**, **SDIO_D3**, **SDIO_CLK**, and **SDIO_CMD**) designed to communicate with external compatible SDIO devices.

2.5.5 DDC (I2C) interface

-  The DDC (I2C) interface is not supported by the “00” and “01” product versions.

SARA-R4 series modules include an I2C-bus compatible DDC interface (**SDA**, **SCL**) available to communicate with a u-blox GNSS receiver and with external I2C devices as for example an audio codec: the SARA-R4 series module acts as an I2C master that can communicate with I2C slaves in accordance with the I2C-bus specifications [\[12\]](#).

The **SDA** and **SCL** pins have internal pull-up to **V_INT**, so there is no need of additional pull-up resistors on the external application board.

2.6 Audio

Audio is not supported by the “00”, “01”, “02”, “52”, “63” and “73” product versions.

SARA-R4 series modules support VoLTE (Voice over LTE Cat M1 radio bearer) for providing audio services.

SARA-R4 series modules include an I2S digital audio interface to transfer digital audio data to/from an external compatible audio device.

The digital audio interface can be made available as an alternative function, in a mutually exclusive way, over the SPI interface pins (**I2S_WA / SPI_MOSI**, **I2S_RXD / SPI_MISO**, **I2S_CLK / SPI_CLK**, **I2S_TXD / SPI_CS**).

2.7 GPIO

SARA-R4 series modules include pins that can be configured as general purpose input/output or to provide custom functions as summarized in [Table 4](#) (for further details, see the SARA-R4 series system integration manual [\[2\]](#) and the SARA-R4 series AT commands manual [\[1\]](#)).

Function	Description	Default GPIO	Configurable GPIOs
Network status indication	Network status: registered / data transmission, no service	--	GPIO1
GNSS supply enable ¹⁹	Enable/disable the supply of a u-blox GNSS receiver connected to the cellular module by the DDC (I2C) interface	--	GPIO2
GNSS data ready ¹⁹	Sense when a u-blox GNSS receiver connected to the module is ready for sending data by the DDC (I2C) interface	--	GPIO3
SIM card detection	SIM card physical presence detection	--	GPIO5
Ring Indicator ²⁰	Events indicator	--	RI
Module status indication	Module switched off or in PSM low power deep sleep mode, versus active or connected mode	--	GPIO1, GPIO2, GPIO3, GPIO4, GPIO5, GPIO6
Last gasp ²⁰	Input to trigger last gasp notification	--	GPIO3, GPIO4, GPIO6
LwM2M pulse ²¹	Output to notify a settable LwM2M event with a configurable pulse	--	GPIO1, GPIO2, GPIO3, GPIO4, GPIO5, GPIO6
General purpose input	Input to sense high or low digital level	--	GPIO1, GPIO2, GPIO3, GPIO4, GPIO5, GPIO6
General purpose output	Output to set the high or the low digital level	--	GPIO1, GPIO2, GPIO3, GPIO4, GPIO6
Pin disabled	Tri-state with an internal active pull-down enabled	GPIO1, GPIO2, GPIO3, GPIO4, GPIO5, GPIO6, RI	GPIO1, GPIO2, GPIO3, GPIO4, GPIO5, GPIO6, RI

Table 4: GPIO custom functions configuration

¹⁹ Not supported by “00” and “01” product versions

²⁰ Not supported by “00”, “01” and SARA-R410M-02B-00 product versions

²¹ Not supported by “00”, “01” and “x2” product versions

3 Pin definition

3.1 Pin assignment

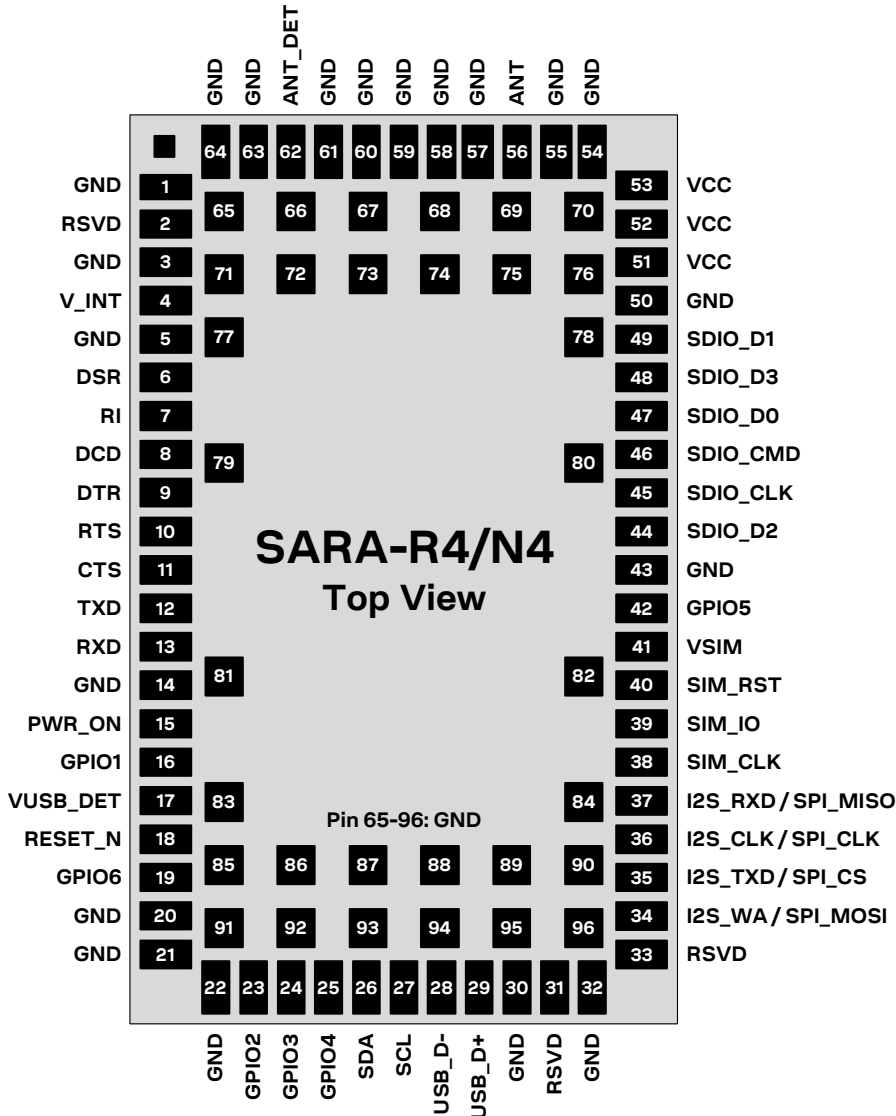

Figure 2: SARA-R4 series pin assignment (top view)

No	Name	Power domain	I/O	Description	Remarks
1	GND	-	N/A	Ground	All the GND pins must be connected to ground
2	RSVD	-	N/A	RESERVED pin	Leave unconnected.
3	GND	-	N/A	Ground	All the GND pins must be connected to ground
4	V_INT	-	O	Generic Digital Interfaces supply output	V_INT = 1.8 V (typical) generated by the module when is switched on, outside low power PSM deep sleep mode. See section 4.2.3 for detailed electrical specs. Provide test point for diagnostic purposes.
5	GND	-	N/A	Ground	All the GND pins must be connected to ground
6	DSR	GDI	O	UART data set ready	Circuit 107 (DSR) in ITU-T V.24. See section 4.2.12 for detailed electrical specs.

No	Name	Power domain	I/O	Description	Remarks
7	RI	GDI	O	UART ring indicator	Circuit 125 (RI) in ITU-T V.24. See section 4.2.12 for detailed electrical specs.
8	DCD	GDI	O	UART data carrier detect	Circuit 109 (DCD) in ITU-T V.24. See section 4.2.12 for detailed electrical specs.
9	DTR	GDI	I	UART data terminal ready	Circuit 108/2 (DTR) in ITU-T V. 24. Internal active pull-up to V_INT. See section 4.2.12 for detailed electrical specs.
10	RTS	GDI	I	UART ready to send	Circuit 105 (RTS) in ITU-T V.24. Internal active pull-up to V_INT. Flow control is not supported by the “00”, “01” and SARA-R410M-02B-00 product versions See section 4.2.12 for detailed electrical specs.
11	CTS	GDI	O	UART clear to send	Circuit 106 (CTS) in ITU-T V.24. Flow control is not supported by the “00”, “01” and SARA-R410M-02B-00 product versions See section 4.2.12 for detailed electrical specs.
12	TXD	GDI	I	UART data input	Circuit 103 (TxD) in ITU-T V.24. Internal pull-down to GND on “00” and R410M-02 versions Internal pull-up to V_INT on other product versions See section 4.2.12 for detailed electrical specs.
13	RXD	GDI	O	UART data output	Circuit 104 (RxD) in ITU-T V.24. See section 4.2.12 for detailed electrical specs.
14	GND	-	N/A	Ground	All the GND pins must be connected to ground
15	PWR_ON	POS	I	Power-on / power-off input	Internal 200 kΩ pull-up resistor. See section 4.2.8 for detailed electrical specs. Provide test point for diagnostic purposes.
16	GPIO1	GDI	I/O	GPIO	Configurable GPIO (see section 2.7). See section 4.2.12 for detailed electrical specs.
17	VUSB_DET	USB	I	USB detect input	Input for VBUS (5 V typical) USB supply sense. See section 4.2.11 for detailed electrical specs. Provide test point for diagnostic purposes.
18	RESET_N	ERS	I	External reset input	Internal 37 kΩ pull-up resistor to V_INT. See section 4.2.9 for detailed electrical specs. Provide test point for diagnostic purposes.
19	GPIO6	GDI	I/O	GPIO	Configurable GPIO (see section 2.7). See section 4.2.12 for detailed electrical specs.
20	GND	-	N/A	Ground	All the GND pins must be connected to ground
21	GND	-	N/A	Ground	All the GND pins must be connected to ground
22	GND	-	N/A	Ground	All the GND pins must be connected to ground
23	GPIO2	GDI	I/O	GPIO	Configurable GPIO (see section 2.7). See section 4.2.12 for detailed electrical specs.
24	GPIO3	GDI	I/O	GPIO	Configurable GPIO (see section 2.7). See section 4.2.12 for detailed electrical specs.
25	GPIO4	GDI	I/O	GPIO	Configurable GPIO (see section 2.7). See section 4.2.12 for detailed electrical specs.
26	SDA	DDC	I/O	I2C bus data line	Fixed open drain. Internal 2.2 kΩ pull-up resistor to V_INT. Not supported by “00” and “01” product versions See section 4.2.13 for detailed electrical specs.

No	Name	Power domain	I/O	Description	Remarks
27	SCL	DDC	O	I2C bus clock line	Fixed open drain. Internal 2.2 kΩ pull-up resistor to V_INT. Not supported by “00” and “01” product versions See section 4.2.13 for detailed electrical specs.
28	USB_D-	USB	I/O	USB Data Line D-	90 Ω nominal differential impedance. Pull-up, pull-down and series resistors, as required by the USB 2.0 specifications [11], are part of the USB pin driver and shall not be provided externally. See section 4.2.11 for detailed electrical specs. Provide test point for diagnostic purposes.
29	USB_D+	USB	I/O	USB Data Line D+	90 Ω nominal differential impedance. Pull-up, pull-down and series resistors, as required by USB 2.0 specifications [11], are part of the USB pin driver and shall not be provided externally. See section 4.2.11 for detailed electrical specs. Provide test point for diagnostic purposes.
30	GND	-	N/A	Ground	All the GND pins must be connected to ground
31	RSVD	-	N/A	RESERVED pin	Leave unconnected.
32	GND	-	N/A	Ground	All the GND pins must be connected to ground
33	RSVD	-	N/A	RESERVED pin	This pin can be connected to GND.
34	I2S_WA / SPI_MOSI	GDI	O / O	I2S word alignment / SPI Master Output Slave Input	I2S word alignment, alternatively configurable as SPI Master Output Slave Input Not supported by “00”, “01”, “x2”, “x3” product versions See section 4.2.12 for detailed electrical specs.
35	I2S_TXD / SPI_CS	GDI	O / O	I2S transmit data / SPI Chip Select	I2S transmit data out, alternatively configurable as SPI Chip Select Not supported by “00”, “01”, “x2”, “x3” product versions See section 4.2.12 for detailed electrical specs.
36	I2S_CLK / SPI_CLK	GDI	O / O	I2S clock / SPI clock	I2S clock, alternatively configurable as SPI clock Not supported by “00”, “01”, “x2”, “x3” product versions See section 4.2.12 for detailed electrical specs.
37	I2S_RXD / SPI_MISO	GDI	I / I	I2S receive data / SPI Master Input Slave Output	I2S receive data input, alternatively configurable as SPI Master Input Slave Output Not supported by “00”, “01”, “x2”, “x3” product versions See section 4.2.12 for detailed electrical specs.
38	SIM_CLK	SIM	O	SIM clock	See section 4.2.10 for detailed electrical specs.
39	SIM_IO	SIM	I/O	SIM data	Internal 4.7 kΩ pull-up resistor to VSIM. See section 4.2.10 for detailed electrical specs.
40	SIM_RST	SIM	O	SIM reset	See section 4.2.10 for detailed electrical specs.
41	VSIM	-	O	SIM supply output	VSIM = 1.80 V typical or 2.95 V typical generated by the module according to the external SIM card type. See section 4.2.3 for detailed electrical specs.
42	GPIO5	GDI	I	SIM detection	SIM card presence detection input, alternatively configurable as GPIO (see section 2.7). See section 4.2.12 for detailed electrical specs.
43	GND	-	N/A	Ground	All the GND pins must be connected to ground
44	SDIO_D2	GDI	I/O	SDIO serial data [2]	Not supported by “00”, “01”, “x2”, “x3” product versions See section 4.2.12 for detailed electrical specs.
45	SDIO_CLK	GDI	O	SDIO serial clock	Not supported by “00”, “01”, “x2”, “x3” product versions See section 4.2.12 for detailed electrical specs.
46	SDIO_CMD	GDI	I/O	SDIO command	Not supported by “00”, “01”, “x2”, “x3” product versions See section 4.2.12 for detailed electrical specs.





No	Name	Power domain	I/O	Description	Remarks
47	SDIO_D0	GDI	I/O	SDIO serial data [0]	Not supported by “00”, “01”, “x2”, “x3” product versions See section 4.2.12 for detailed electrical specs.
48	SDIO_D3	GDI	I/O	SDIO serial data [3]	Not supported by “00”, “01”, “x2”, “x3” product versions See section 4.2.12 for detailed electrical specs.
49	SDIO_D1	GDI	I/O	SDIO serial data [1]	Not supported by “00”, “01”, “x2”, “x3” product versions See section 4.2.12 for detailed electrical specs.
50	GND	-	N/A	Ground	All the GND pins must be connected to ground
51	VCC	-	I	Module supply input	All VCC pins must be connected to external supply. SARA-R404M, SARA-R410M and SARA-N410: supply input for all internal parts. SARA-R412M: supply input for internal BB PMU. See section 4.2.3 and 4.2.4 for detailed specs.
52	VCC	-	I	Module supply input	All VCC pins must be connected to external supply. SARA-R404M, SARA-R410M and SARA-N410: supply input for all internal parts. SARA-R412M: supply input for internal RF PA. See section 4.2.3 and 4.2.4 for detailed specs.
53	VCC	-	I	Module supply input	All VCC pins must be connected to external supply. SARA-R404M, SARA-R410M and SARA-N410: supply input for all internal parts. SARA-R412M: supply input for internal RF PA. See section 4.2.3 and 4.2.4 for detailed specs.
54	GND	-	N/A	Ground	All the GND pins must be connected to ground
55	GND	-	N/A	Ground	All the GND pins must be connected to ground
56	ANT	-	I/O	RF input/output	50 Ω nominal impedance. See section 4.2.5 for detailed electrical specs.
57	GND	-	N/A	Ground	All the GND pins must be connected to ground
58	GND	-	N/A	Ground	All the GND pins must be connected to ground
59	GND	-	N/A	Ground	All the GND pins must be connected to ground
60	GND	-	N/A	Ground	All the GND pins must be connected to ground
61	GND	-	N/A	Ground	All the GND pins must be connected to ground
62	ANT_DET	ADC	I	Antenna detection	Antenna presence detection function. See section 4.2.7 for detailed electrical specs.
63	GND	-	N/A	Ground	All the GND pins must be connected to ground
64	GND	-	N/A	Ground	All the GND pins must be connected to ground
65-96	GND	-	N/A	Ground	All the GND pins must be connected to ground

Table 5: SARA-R4 series pin-out

 For more information about the pin-out, see the u-blox SARA-R4 series system integration manual [2].

 See appendix A for an explanation of the abbreviations and terms used.

4 Electrical specifications

-  Stressing the device above one or more of the ratings listed in the Absolute Maximum Rating section may cause permanent damage. These are stress ratings only. Operating the module at these or at any conditions other than those specified in the Operating Conditions sections (section 4.2) of the specification should be avoided. Exposure to Absolute Maximum Rating conditions for extended periods may affect device reliability.
-  Operating condition ranges define those limits within which the functionality of the device is guaranteed.
-  Electrical characteristics are defined according to the verification on a representative number of samples or according to the simulation.
-  Where application information is given, it is advisory only and does not form part of the specification.

4.1 Absolute maximum rating

-  Limiting values given below are in accordance with Absolute Maximum Rating System (IEC 134).

Symbol	Description	Condition	Min.	Max.	Unit
VCC	Module supply voltage	Input DC voltage at VCC pins (SARA-R404M)	-0.5	6.0	V
		Input DC voltage at VCC pins (SARA-R410M, SARA-R412M and SARA-N410)	-0.5	5.2	V
VUSB_DET	USB detection pin	Input DC voltage at VUSB_DET pin	-0.5	5.5	V
USB	USB D+/D- pins	Input DC voltage at USB interface pins	-0.3	3.6	V
GDI	Generic digital interfaces	Input DC voltage at Generic digital interfaces pins	-0.3	2.3	V
DDC	DDC interface	Input DC voltage at DDC interface pins	-0.3	2.3	V
SIM	SIM interface	Input DC voltage at SIM interface pins	-0.3	3.5	V
ERS	External reset input	Input DC voltage at RESET_N pin	-0.5	2.1	V
POS	Power-on input	Input DC voltage at PWR_ON pin	-0.5	2.1	V
ADC	Antenna detection input	Input DC voltage at ANT_DET pin	-0.5	4.3	V
Rho_ANT	Antenna ruggedness	Output RF load mismatch ruggedness at ANT pins		10:1	VSWR
Tstg	Storage temperature		-40	+85	°C

Table 6: Absolute maximum ratings

-  The product is not protected against overvoltage or reversed voltages. If necessary, voltage spikes exceeding the voltage specifications given in the table above, must be limited to values within the specified boundaries by using appropriate protection devices.

4.1.1 Maximum ESD

Parameter	Min	Typical	Max	Unit	Remarks
ESD sensitivity for all pins			1'000	V	Human Body Model according to JESD22-A114

Table 7: Maximum ESD ratings

-  u-blox cellular modules are Electrostatic Sensitive Devices and require special precautions when handling. See section 7.4 for ESD handling instructions.

4.2 Operating conditions

Unless otherwise indicated, all operating condition specifications are at an ambient temperature of +25 °C.

Operation beyond the operating conditions is not recommended and extended exposure beyond them may affect device reliability.

4.2.1 Operating temperature range

Parameter	Min.	Typ.	Max.	Unit	Remarks
Normal operating temperature	-20	+25	+65	°C	Normal operating temperature range (fully functional and meet 3GPP / ETSI specifications)
Extended operating temperature	-40		+85	°C	Extended operating temperature range (RF performance may be affected outside normal operating range, though module is fully functional)

Table 8: Environmental conditions

4.2.2 Thermal parameters

Symbol	Parameter	Min.	Typ.	Max.	Unit	Remarks
Ψ_{M-A}	Module-to-Ambient thermal parameter		10		°C/W	Thermal characterization parameter $\Psi_{M-A} = (T_M - T_A) / P_H$ proportional to the temperature difference between the internal temperature sensor of the module (T_M) and the ambient temperature (T_A), produced by the module heat power dissipation (P_H), with the module mounted on a 79 x 62 x 1.41 mm 4-Layer PCB with a high coverage of copper, in still air conditions
Ψ_{M-C}	Module-to-Case thermal parameter		2		°C/W	Thermal characterization parameter $\Psi_{M-C} = (T_M - T_C) / P_H$ proportional to the temperature difference between the internal temperature sensor of the module (T_M) and the ambient temperature (T_C), produced by the module heat power dissipation (P_H), with the module mounted on a 79 x 62 x 1.41 mm 4-Layer PCB with a high coverage of copper, with a robust aluminum heat-sink and with forced air ventilation, i.e. reducing to a value close to 0 °C/W the thermal resistance from the case of the module to the ambient

Table 9: Thermal characterization parameters of the module

4.2.3 Supply/power pins

Symbol	Parameter	Module	Min.	Typical	Max.	Unit
VCC	Module supply normal operating input voltage ²²	SARA-R404M	3.2	3.8	4.2	V
		SARA-R410M SARA-N410				
	Module supply extended operating input voltage ²³	SARA-R412M	3.0	3.8	4.5	V
		SARA-R404M SARA-R410M SARA-N410				
	SARA-R412M	3.0	3.8	4.5	V	

Table 10: Input characteristics of the Supply/Power pins

Symbol	Parameter	Module	Min.	Typical	Max.	Unit
VSIM	SIM supply output voltage with 1.8 V external SIM	All		1.80		V
	SIM supply output voltage with 3.0 V external SIM	All		2.95		V
V_INT	Generic Digital Interfaces supply output voltage	All		1.80		V
I_INT	Generic Digital Interfaces supply output current capability	All			70	mA

Table 11: Output characteristics of the Supply/Power pins

²² Input voltage at VCC must be above the normal operating range minimum limit to switch on the module. RF performance may be affected when the input voltage at VCC drops below the herein stated normal operating range minimum limit, though the module is still fully functional.

²³ Ensure that input voltage at VCC never drops below the extended operating range minimum limit during module operation: the cellular module may switch off when the VCC voltage value drops below the herein stated extended operating range minimum limit.²⁴ All values with VCC = 3.8 V, with UART connected and USB disconnected.

4.2.4 Current consumption

Mode	Condition	Tx power	Module	Min	Typ	Max	Unit
Power Off Mode (module switched off, RTC off)	Averaged current value	--	All		6		μA
PSM Deep Sleep Mode (RTC on)	Averaged current value	--	All		8		μA
Low Power Mode (+UPSV=4)	Averaged current value (rock bottom)	--	R410M, R412M, N410		0.6		mA
	Averaged current value (eDRX 20.48 s)	--	R410M, R412M, N410		1.6		mA
Active Mode (Power Saving / Low Power Mode disabled, registered with network)	Averaged current value	--	All		9		mA
LTE Cat NB1 Connected Mode (Data Tx / Rx)	Averaged current value	Minimum	All		60		mA
			0 dBm	R410M, N410		65	
			R412M		70		mA
		12 dBm	R410M, N410		80		mA
			R412M		90		mA
		18 dBm	R410M, N410		100		mA
			R412M		130		mA
		Maximum	R410M, N410		140		mA
			R412M		240		mA
		Peak current value during Tx	Maximum	R410M, N410			
R412M						0.9	A
LTE Cat M1 Connected Mode (Data Tx / Rx)	Averaged current value	Minimum	All		100		mA
			0 dBm	R404M, R410M		105	
			R412M		110		mA
		12 dBm	R404M, R410M		125		mA
			R412M		140		mA
		18 dBm	R404M, R410M		150		mA
			R412M		200		mA
		Maximum	R404M, R410M		190		mA
			R412M		360		mA
		Peak current value during Tx	Maximum	R404M, R410M			
R412M						0.9	A
2G Connected Mode (Data Tx / Rx)	Averaged current value during GMSK 1-Tx/1-Rx call 850/900 MHz bands	Maximum	R412M		200		mA
	Peak current value during GMSK 1-slot Tx, 850/900 MHz bands	Maximum	R412M		1.5	1.9	A

Table 12: Module VCC current consumption ²⁴

²⁴ All values with VCC = 3.8 V, with UART connected and USB disconnected.

4.2.5 LTE RF characteristics

The LTE bands supported by SARA-R4 series modules are defined in the [Table 2](#), while the following [Table 13](#) describes the Transmitting and Receiving frequencies according to 3GPP TS 36.521-1 [8].

Parameter		Min.	Max.	Unit	Remarks
Frequency range FDD Band 12 (700 MHz)	Uplink	699	716	MHz	Module transmit
	Downlink	729	746	MHz	Module receive
Frequency range FDD Band 28 (700 MHz)	Uplink	703	748	MHz	Module transmit
	Downlink	758	803	MHz	Module receive
Frequency range FDD Band 13 (700 MHz)	Uplink	777	787	MHz	Module transmit
	Downlink	746	756	MHz	Module receive
Frequency range FDD Band 20 (800 MHz)	Uplink	832	862	MHz	Module transmit
	Downlink	791	821	MHz	Module receive
Frequency range FDD Band 26 (850 MHz)	Uplink	814	849	MHz	Module transmit
	Downlink	859	894	MHz	Module receive
Frequency range FDD Band 18 (850 MHz)	Uplink	815	830	MHz	Module transmit
	Downlink	860	875	MHz	Module receive
Frequency range FDD Band 5 (850 MHz)	Uplink	824	849	MHz	Module transmit
	Downlink	869	894	MHz	Module receive
Frequency range FDD Band 19 (850 MHz)	Uplink	830	845	MHz	Module transmit
	Downlink	875	890	MHz	Module receive
Frequency range FDD Band 8 (900 MHz)	Uplink	880	915	MHz	Module transmit
	Downlink	925	960	MHz	Module receive
Frequency range FDD Band 4 (1700 MHz)	Uplink	1710	1755	MHz	Module transmit
	Downlink	2110	2155	MHz	Module receive
Frequency range FDD Band 3 (1800 MHz)	Uplink	1710	1785	MHz	Module transmit
	Downlink	1805	1880	MHz	Module receive
Frequency range FDD Band 2 (1900 MHz)	Uplink	1850	1910	MHz	Module transmit
	Downlink	1930	1990	MHz	Module receive
Frequency range FDD Band 25 (1900 MHz)	Uplink	1850	1915	MHz	Module transmit
	Downlink	1930	1995	MHz	Module receive
Frequency range FDD Band 1 (2100 MHz)	Uplink	1920	1980	MHz	Module transmit
	Downlink	2110	2170	MHz	Module receive

Table 13: LTE operating RF frequency bands

SARA-R4 series modules include a UE Power Class 3 LTE Cat M1 / NB1 transmitter (see [Table 2](#)), with output power and characteristics according to 3GPP TS 36.521-1 [8].

SARA-R4 series modules LTE receiver characteristics are compliant to 3GPP TS 36.521-1 [8], with LTE conducted receiver sensitivity performance described in [Table 14](#) and [Table 15](#).

Parameter	Min.	Typical	Max.	Unit	Remarks
Receiver input sensitivity Band 12 (700 MHz)		-107.0		dBm	Without repetitions
Receiver input sensitivity Band 28 (700 MHz)		-105.0		dBm	Without repetitions
Receiver input sensitivity Band 13 (700 MHz)		-105.0		dBm	Without repetitions
Receiver input sensitivity Band 20 (800 MHz)		-105.0		dBm	Without repetitions
Receiver input sensitivity Band 5 / 18 / 19 / 26 (850 MHz)		-105.5		dBm	Without repetitions
Receiver input sensitivity Band 8 (900 MHz)		-106.5		dBm	Without repetitions
Receiver input sensitivity Band 4 (1700 MHz)		-107.5		dBm	Without repetitions
Receiver input sensitivity Band 3 (1800 MHz)		-106.0		dBm	Without repetitions
Receiver input sensitivity Band 2 / 25 (1900 MHz)		-106.0		dBm	Without repetitions
Receiver input sensitivity Band 1 (2100 MHz)		-107.5		dBm	Without repetitions

Condition: 50 Ω source, throughput > 95%, QPSK modulation, other settings as per 3GPP TS 36.521-1 [8]

Table 14: LTE Cat M1 receiver sensitivity performance

Parameter	Min.	Typical	Max.	Unit	Remarks
Receiver input sensitivity Band 12 (700 MHz)		-113.5		dBm	Without repetitions
Receiver input sensitivity Band 28 (700 MHz)		-112.0		dBm	Without repetitions
Receiver input sensitivity Band 13 (700 MHz)		-112.0		dBm	Without repetitions
Receiver input sensitivity Band 20 (800 MHz)		-112.0		dBm	Without repetitions
Receiver input sensitivity Band 5 / 18 / 19 / 26 (850 MHz)		-112.5		dBm	Without repetitions
Receiver input sensitivity Band 8 (900 MHz)		-113.0		dBm	Without repetitions
Receiver input sensitivity Band 4 (1700 MHz)		-114.0		dBm	Without repetitions
Receiver input sensitivity Band 3 (1800 MHz)		-113.0		dBm	Without repetitions
Receiver input sensitivity Band 2 / 25 (1900 MHz)		-113.0		dBm	Without repetitions
Receiver input sensitivity Band 1 (2100 MHz)		-114.0		dBm	Without repetitions

Condition: 50 Ω source, throughput > 95%, other settings as per 3GPP TS 36.521-1 [8]

Table 15: LTE Cat NB1 receiver sensitivity performance

4.2.6 2G RF characteristics

The 2G bands supported by SARA-R4 series modules are defined in the [Table 2](#), while the following [Table 16](#) describes the Transmitting and Receiving frequencies according to 3GPP TS 51.010-1 [\[9\]](#).

Parameter		Min	Max	Unit	Remarks
Frequency range GSM 850	Uplink	824	849	MHz	Module transmit
	Downlink	869	894	MHz	Module receive
Frequency range E-GSM 900	Uplink	880	915	MHz	Module transmit
	Downlink	925	960	MHz	Module receive
Frequency range DCS 1800	Uplink	1710	1785	MHz	Module transmit
	Downlink	1805	1880	MHz	Module receive
Frequency range PCS 1900	Uplink	1850	1910	MHz	Module transmit
	Downlink	1930	1990	MHz	Module receive

Table 16: 2G operating RF frequency bands

SARA-R4 series modules include a GMSK Power Class 4 transmitter for GSM 850 and E-GSM 900 bands, a GMSK Power Class 1 transmitter for DCS 1800 and PCS 1900 bands, a 8-PSK Power Class E2 transmitter for all 2G bands (see [Table 2](#)), with output power and characteristics according to 3GPP TS 51.010-1 [\[9\]](#).

SARA-R4 series modules 2G receiver characteristics are compliant to 3GPP TS 51.010-1 [\[9\]](#), with conducted receiver sensitivity performance described in [Table 17](#).

Parameter	Min	Typical	Max	Unit	Remarks
Receiver input sensitivity GSM 850		-109		dBm	Downlink RF level @ BER Class II < 2.4 %
Receiver input sensitivity E-GSM 900		-109		dBm	Downlink RF level @ BER Class II < 2.4 %
Receiver input sensitivity DCS 1800		-109		dBm	Downlink RF level @ BER Class II < 2.4 %
Receiver input sensitivity PCS 1900		-109		dBm	Downlink RF level @ BER Class II < 2.4 %

Condition: 50 Ω source

Table 17: 2G receiver sensitivity performance

4.2.7 ANT_DET pin characteristics

Pin Name	Parameter	Min.	Typ.	Max.	Unit	Remarks
ANT_DET	Output DC current pulse value		35		μA	
	Output DC current pulse time length		1160		μs	

Table 18: ANT_DET pin characteristics

4.2.8 PWR_ON pin

Parameter	Min.	Typical	Max.	Unit	Remarks
Internal supply for PWR_ON Input Signal		1.8		V	The PWR_ON input is pulled up to an internal voltage rail minus a diode drop: the voltage value present at PWR_ON input pin is normally 0.8 V typical.
Low-level input	-0.30		0.35	V	
Pull-up resistance	150	200	250	k Ω	Internal active pull-up
Input leakage current	-0.20		0.20	μ A	
PWR_ON low time	0.15		3.20	s	Low time to trigger module switch on from power off mode
	0.15		3.20	s	Low time to trigger module wake-up from PSM deep sleep
	1.50			s	Low time to trigger module switch off

Table 19: PWR_ON pin characteristics

4.2.9 RESET_N pin

Parameter	Min.	Typical	Max.	Unit	Remarks
Internal supply for RESET_N Input Signal		1.8		V	
Low-level input	-0.30		0.63	V	
Pull-up resistance		37		k Ω	Internal active pull-up
Input leakage current	-0.20		0.20	μ A	
RESET_N low time	10			s	Low time to trigger module abrupt emergency switch off

Table 20: RESET_N pin characteristics

4.2.10 SIM pins

The SIM pins are a dedicated interface to the external SIM card/chip. The electrical characteristics fulfill the regulatory specification requirements. The values in [Table 21](#) are for information only.

Parameter	Min.	Typ.	Max.	Unit	Remarks
Low-level input	-0.30		0.2*VSIM	V	
High-level input		0.7*VSIM	VSIM+0.3	V	
Low-level output			0	V	Max value at I _{OL} = +2.0 mA
High-level output		0.8*VSIM	VSIM	V	Max value at I _{OL} = +2.0 mA
Internal pull-up resistor on SIM_IO			4.7	k Ω	Internal pull-up to VSIM supply
Input leakage current	-2		2	μ A	V _{IN} = 0 V or V _{IN} = VSIM
Clock frequency on SIM_CLK			4.8	MHz	

Table 21: SIM pin characteristics

4.2.11 USB pins

USB data lines (**USB_D+**/**USB_D-**) are compliant to the USB 2.0 high-speed specification. See the Universal Serial Bus revision 2.0 specification [11] for detailed electrical characteristics.

Parameter	Min.	Typical	Max.	Unit	Remarks
USB detection voltage on pin VUSB_DET	4.40	5.00	5.25	V	
High-speed squelch detection threshold (input differential signal amplitude)	100		150	mV	
High speed disconnect detection threshold (input differential signal amplitude)	525		625	mV	
High-speed data signaling input common mode voltage range	-50		500	mV	
High-speed idle output level	-10		10	mV	
High-speed data signaling output high level	360		440	mV	
High-speed data signaling output low level	-10		10	mV	
Chirp J level (output differential voltage)	700		1100	mV	
Chirp K level (output differential voltage)	-900		-500	mV	

Table 22: USB pin characteristics

4.2.12 Generic digital interfaces pins

Parameter	Min	Typical	Max	Unit	Remarks
Internal supply for GDI domain		1.80		V	Digital I/O Interfaces supply (V_INT)
Low-level input	-0.30	0.00	0.63	V	
High-level input	1.17	1.80	2.10	V	
Low-level output		0.00	0.45	V	Max value at IOL = +2.0 mA
High-level output	1.35	1.80		V	Min value at IOH = -2.0 mA
Input leakage current	-1		1	μA	V _{IN} = 0 V or V _{IN} = 1.8V
Internal pull-up / pull-down resistance	55		390	kΩ	

Table 23: GDI pin characteristics

4.2.13 DDC (I2C) pins

DDC (I2C) lines (**SCL** and **SDA**) are compliant to the I2C-bus standard mode specification. See the I2C-bus specification [12] for detailed electrical characteristics.

Parameter	Min	Typical	Max	Unit	Remarks
Internal supply for GDI domain		1.80		V	Digital I/O Interfaces supply (V_INT)
Low-level input	-0.30	0.00	0.63	V	
High-level input	1.17	1.80	2.10	V	
Low-level output		0.00	0.45	V	Max value at I _{OL} = +2.0 mA
Internal pull-up resistance		2.2		kΩ	
Input/output leakage current	-1		1	μA	V _{IN} = 0 V or V _{IN} = 1.8V
Clock frequency on SCL		100		kHz	

Table 24: DDC (I2C) pin characteristics

4.3 Parameters for ATEX applications

This section provides useful parameters and information to integrate SARA-R4 series modules in applications intended for use in areas with potentially explosive atmospheres (ATEX), describing:

- Total internal capacitance and inductance of the modules (see [Table 25](#))
- Maximum RF output power and voltage at the antenna (**ANT**) pin of the modules (see [Table 26](#))

 Any specific applicable requirement for the implementation of the apparatus integrating the SARA-R4 series modules, intended for use in potentially explosive atmospheres, must be fulfilled according to the exact applicable standards: check the detailed requisites on the pertinent normative for the application, as for example the IEC 60079-0 [\[13\]](#), IEC 60079-11 [\[14\]](#), and IEC 60079-26 [\[15\]](#) standards.

 The certification of the application device that integrates a SARA-R4 series module and the compliance of the application device with all the applicable certification schemes, directives and standards required for use in potentially explosive atmospheres are the sole responsibility of the application device manufacturer.

[Table 25](#) describes the maximum total internal capacitance and the maximum total internal inductance, considering internal parts tolerance, of the SARA-R4 series modules.

Module	Parameter	Description	Value	Unit
SARA-R404M	Ci	Maximum total internal capacitance	510	μF
	Li	Maximum total internal inductance	9.2	μH
SARA-R410M, SARA-N410	Ci	Maximum total internal capacitance	504	μF
	Li	Maximum total internal inductance	9.3	μH
SARA-R412M	Ci	Maximum total internal capacitance	507	μF
	Li	Maximum total internal inductance	9.4	μH

Table 25: SARA-R4 series maximum total internal capacitance and maximum total internal inductance

[Table 26](#) describes the maximum RF output power transmitted by SARA-R4 series modules from the antenna (**ANT**) pin as Power Class 3 User Equipment for the LTE Cat M1 / NB1 bands and/or as Power Class 4 Mobile Stations for GSM 850 / E-GSM 900 bands.

Module	Parameter	Description	Value	Unit
SARA-R404M	ANT Pout	Maximum RF output power from ANT pin	25.00	dBm
SARA-R410M	ANT Pout	Maximum RF output power from ANT pin	25.00	dBm
SARA-N410	ANT Pout	Maximum RF output power from ANT pin	25.00	dBm
SARA-R412M	ANT Pout	Maximum RF output power from ANT pin	33.00	dBm

Table 26: SARA-R4 series maximum RF output power

 The SARA-R4 series modules do not contain internal blocks that increase the input voltage (such as step-up, duplicators, or boosters) except for the antenna (**ANT**) pin, for which the maximum RF output power shown in [Table 26](#).

5 Mechanical specifications

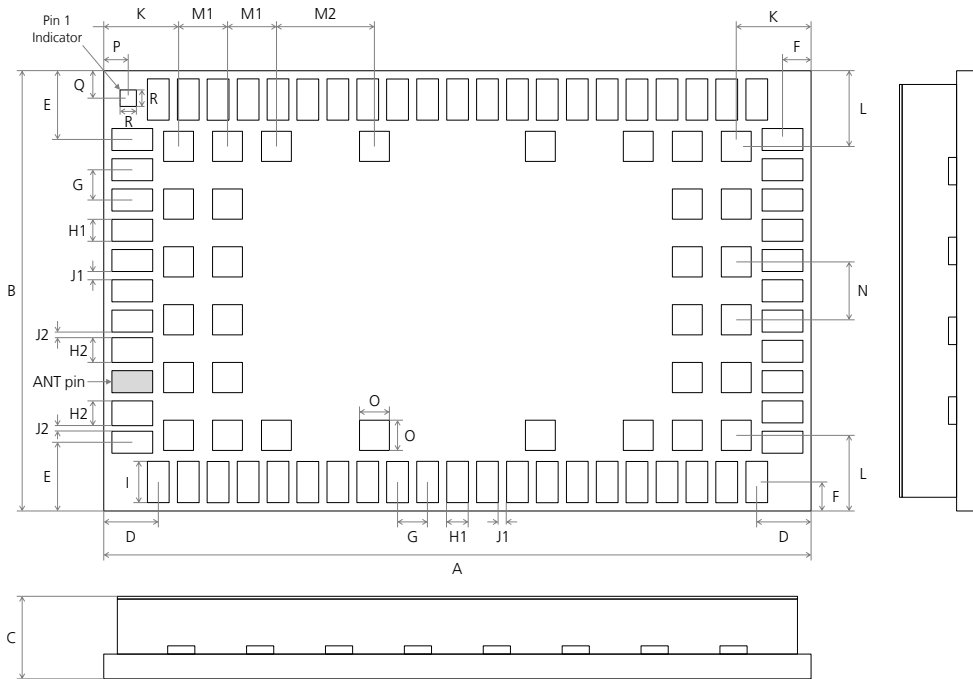

Figure 3: SARA-R4 series dimensions (bottom and side views)

Parameter	Description	Typical		Tolerance	
A	Module height [mm]	26.0	(1023.6 mil)	+0.20/-0.20	(+7.9/-7.9 mil)
B	Module width [mm]	16.0	(629.9 mil)	+0.20/-0.20	(+7.9/-7.9 mil)
C	Module thickness [mm]	2.53	(99.5 mil)	+0.25/-0.15	(+9.8/-5.9 mil)
D	Horizontal edge to lateral pin pitch [mm]	2.0	(78.7 mil)	+0.20/-0.20	(+7.9/-7.9 mil)
E	Vertical edge to lateral pin pitch [mm]	2.5	(98.4 mil)	+0.20/-0.20	(+7.9/-7.9 mil)
F	Edge to lateral pin pitch [mm]	1.05	(41.3 mil)	+0.20/-0.20	(+7.9/-7.9 mil)
G	Lateral pin to pin pitch [mm]	1.1	(43.3 mil)	+0.05/-0.05	(+2.0/-2.0 mil)
H1	Lateral pin height [mm]	0.8	(31.5 mil)	+0.05/-0.05	(+2.0/-2.0 mil)
H2	Lateral pin close to ANT height [mm]	0.9	(35.4 mil)	+0.05/-0.05	(+2.0/-2.0 mil)
I	Lateral pin width [mm]	1.5	(59.1 mil)	+0.05/-0.05	(+2.0/-2.0 mil)
J1	Lateral pin to pin distance [mm]	0.3	(11.8 mil)	+0.05/-0.05	(+2.0/-2.0 mil)
J2	Lateral pin to pin close to ANT distance [mm]	0.2	(7.9 mil)	+0.05/-0.05	(+2.0/-2.0 mil)
K	Horizontal edge to central pin pitch [mm]	2.75	(108.3 mil)	+0.20/-0.20	(+7.9/-7.9 mil)
L	Vertical edge to central pin pitch [mm]	2.75	(108.3 mil)	+0.20/-0.20	(+7.9/-7.9 mil)
M1	Central pin to pin horizontal pitch [mm]	1.8	(70.9 mil)	+0.05/-0.05	(+2.0/-2.0 mil)
M2	Central pin to pin horizontal pitch [mm]	3.6	(141.7 mil)	+0.05/-0.05	(+2.0/-2.0 mil)
N	Central pin to pin vertical pitch [mm]	2.1	(82.7 mil)	+0.05/-0.05	(+2.0/-2.0 mil)
O	Central pin height and width [mm]	1.1	(43.3 mil)	+0.05/-0.05	(+2.0/-2.0 mil)
P	Horizontal edge to pin 1 indicator pitch [mm]	0.9	(35.4 mil)	+0.20/-0.20	(+7.9/-7.9 mil)
Q	Vertical edge to pin 1 indicator pitch [mm]	1.0	(39.4 mil)	+0.20/-0.20	(+7.9/-7.9 mil)
R	Pin 1 indicator height and width [mm]	0.6	(23.6 mil)	+0.05/-0.05	(+2.0/-2.0 mil)
Weight	Module weight [g]	< 3			

Table 27: SARA-R4 series dimensions

Module height tolerance ± 0.20 mm may be exceeded close to the corners of the PCB due to the cutting process: in the worst cases, the height could be $+0.40$ mm longer than the typical value.

For information regarding footprint and paste mask recommended for the application board integrating the cellular module, see the SARA-R4 series system integration manual [2].

6 Qualification and approvals

6.1 Approvals

SARA-R4 series modules comply with the Directive 2011/65/EU of the European Parliament and the Council on the Restriction of Use of certain Hazardous Substances in Electrical and Electronic Equipment (EU RoHS 2) and its amendment Directive (EU) 2015/863 (EU RoHS 3).

SARA-R4 series modules are RoHS 3 compliant.

No natural rubbers, hygroscopic materials, or materials containing asbestos are employed.

Table 28 summarizes the main approvals achieved or planned for SARA-R410M and SARA-R412M modules.

Certification	SARA-R410M-01B	SARA-R410M-02B	SARA-R410M-52B	SARA-R410M-63B	SARA-R410M-73B	SARA-R412M-02B
PTCRB	LTE Cat M1 Band 2,4,5,12	LTE Cat M1, NB1 Band 2,3,4,5,8,12,13,20,28	LTE Cat M1 Band 2,4,5,12,13			LTE Cat M1, NB1 Band 2,4,5,12
GCF			LTE Cat M1 Band 2,4,5,12,13			
CE Europe		LTE Cat M1, NB1 Band 3,8,20				LTE Cat M1, NB1 Band 3,8,20 2G Band 900,1800
FCC US	LTE Cat M1 Band 2,4,5,12	LTE Cat M1, NB1 Band 2,4,5,12,13,25 ²⁵	LTE Cat M1 Band 2,4,5,12,13			LTE Cat M1, NB1 Band 2,4,5,12,13 2G Band 850,1900
FCC ID	XPY2AGQN4NNN	XPY2AGQN4NNN	XPY2AGQN4NNN			XPYUBX18ZO01
ISED Canada	LTE Cat M1 Band 2,4,5,12	LTE Cat M1, NB1 Band 2,4,5,12,13	LTE Cat M1 Band 2,4,5,12,13			LTE Cat M1, NB1 Band 2,4,5,12,13 2G Band 850,1900
ISED ID	8595A-2AGQN4NNN	8595A-2AGQN4NNN	8595A-2AGQN4NNN			8595A-UBX18ZO01
IFT Mexico	M1 Band 2,4,5,12					
RCM Australia		LTE Cat M1 Band 3,5,8,28				
NCC Taiwan		LTE Cat M1, NB1 Band 3,8,28				

²⁵ LTE Cat M1 only

Certification	SARA-R410M-01B	SARA-R410M-02B	SARA-R410M-52B	SARA-R410M-63B	SARA-R410M-73B	SARA-R412M-02B
GITEKI Japan		LTE Cat M1, NB1 Band 1,8,18,19,26		LTE Cat M1, NB1 Band 1,8,18,19,26		
KC Korea					LTE Cat M1 Band 3,5,26	
Verizon		LTE Cat M1 Band 4,13	LTE Cat M1 Band 4,13			
AT&T	LTE Cat M1 Band 2,4,5,12	LTE Cat M1 Band 2,4,5,12	LTE Cat M1 Band 2,4,5,12			LTE Cat M1 Band 2,4,5,12
T-Mobile US						LTE Cat NB1 Band 2,4,5,12
Sprint		LTE Cat M1 Band 25				
US Cellular		LTE Cat M1 Band 2,4,5,12				
Bell	LTE Cat M1 Band 2,4,5,12					
Telus	LTE Cat M1 Band 2,4,5,12	LTE Cat M1 Band 2,4,5,12				
Telstra		LTE Cat M1 Band 3,5,8,28				
Softbank				LTE Cat M1 Band 1,8		
NTT DOCOMO				LTE Cat M1 Band 1,19		
SKT					LTE Cat M1 Band 3,5,26	

Table 28: Summary of main certification approvals achieved or planned for SARA-R410M and SARA-R412M modules, with related RAT and bands



-  For guidelines and notices about end-device compliance with certification approvals requirements see the SARA-R4 series system integration manual [2].
-  The above listed certifications might not be available for all the different product type numbers. Please contact the u-blox office or sales representative nearest you for the full comprehensive list of approvals and for further specific info about all country, conformance and network operators' certifications available for the selected product ordering number.

Table 29 summarizes how some of the SARA-R4 series modules are identified by various bodies.

Body	Description	SARA-R410M-01B	SARA-R410M-02B	SARA-R410M-52B	SARA-R412M-02B
PTCRB	Model Name	SARA-R410M	SARA-R410M-02B	SARA-R410M-52B	SARA-R412M
GCF	Model Name	--	--	SARA-R410M-52B	--
	Marketing Name	--	--	SARA-R410M-52B	--
GSMA	Model Name	SARA-R410M	SARA-R410M	SARA-R410M-52B	SARA-R412M
	Marketing Name	SARA-R410M	SARA-R410M-02B	SARA-R410M-52B	SARA-R412M
FCC US	ID	XPY2AGQN4NNN	XPY2AGQN4NNN	XPY2AGQN4NNN	XPYUBX18ZO01
	Product Name	SARA-R410M	SARA-R410M-02B	SARA-R410M-02B	SARA-R412M
ISED Canada	ID	8595A-2AGQN4NNN	8595A-2AGQN4NNN	8595A-2AGQN4NNN	8595A-UBX18ZO01
	HVIN	SARA-R410M	SARA-R410M	SARA-R410M	SARA-R412M
	PMN	SARA-R410M	SARA-R410M	SARA-R410M	SARA-R412M
RED Europe	Model Name	--	SARA-R410M-02B	--	SARA-R412M
RCM Australia	Model Number	--	SARA-R410M-02B	--	--
AT&T	Model Name	SARA-R410M	SARA-R410M-02B	SARA-R410M-52B	SARA-R412M
Verizon	Model Name	--	SARA-R410M-02B	SARA-R410M-52B	--
Sprint	Model Name	--	SARA-R410M	--	--
T-Mobile US	Model Name	--	--	--	--
Deutsche Telekom	Model Name	--	--	--	--
Vodafone	Model Name	--	--	--	--
Telstra	Model Name	--	SARA-R410M-02B	--	--

Table 29: Summary of some SARA-R4 series modules' identification by various bodies

6.2 Reliability tests

Tests for product family qualifications according to ISO 16750 "Road vehicles – Environmental conditions and testing for electrical and electronic equipment", and appropriate standards.

7 Product handling & soldering

7.1 Packaging

SARA-R4 series modules are delivered as hermetically sealed, reeled tapes to enable efficient production, production lot set-up and tear-down. For more information about packaging, see the u-blox package information user guide [3].

7.1.1 Reels

SARA-R4 series modules are deliverable in quantities of 250 pieces on a reel. The modules are delivered using reel type B2 described in Figure 4 and in the u-blox package information user guide [3].

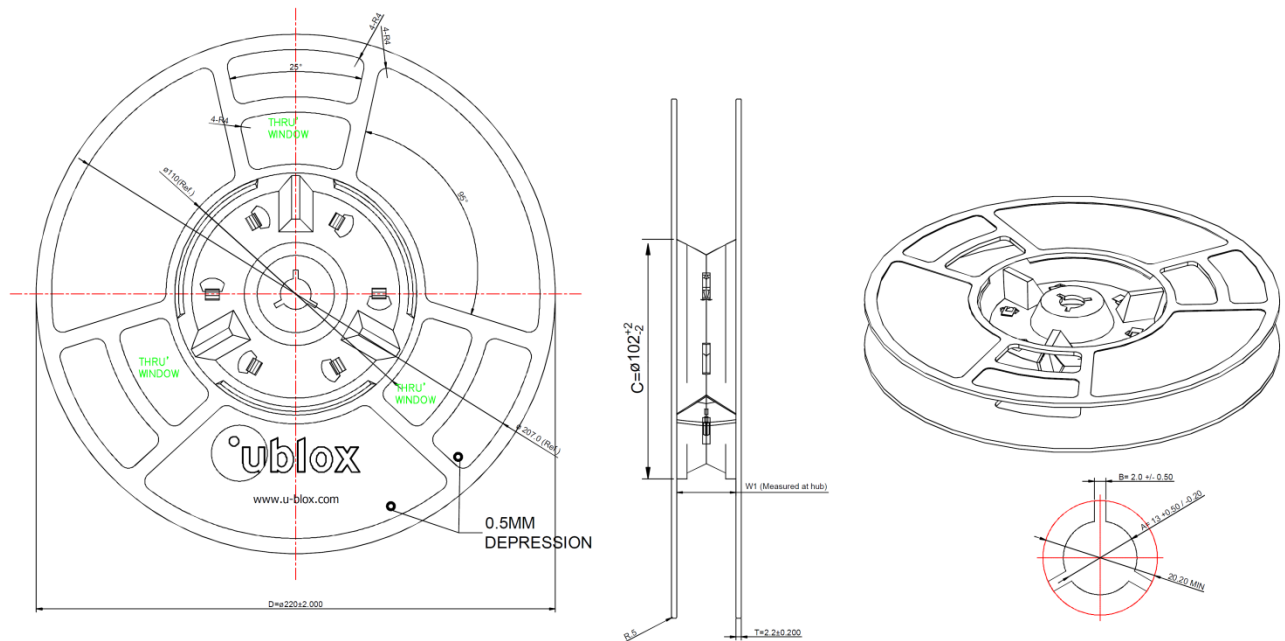

NOTE: ALL DIMENSIONS IN MILLIMETERS

Figure 4: SARA-R4 series modules reel

Parameter	Specification
Reel type	B2
Delivery quantity	250

Table 30: Reel information for SARA-R4 series modules

Quantities of less than 250 pieces are also available. Contact u-blox for more information.

7.1.2 Tapes

Figure 5 shows the position and the orientation of SARA-R4 series modules as they are delivered on the tape, while Figure 6 and Table 31 specify the dimensions of the tape.

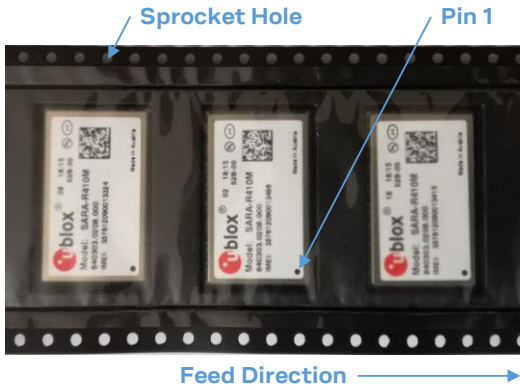

Figure 5: Orientation of SARA-R4 series modules on tape

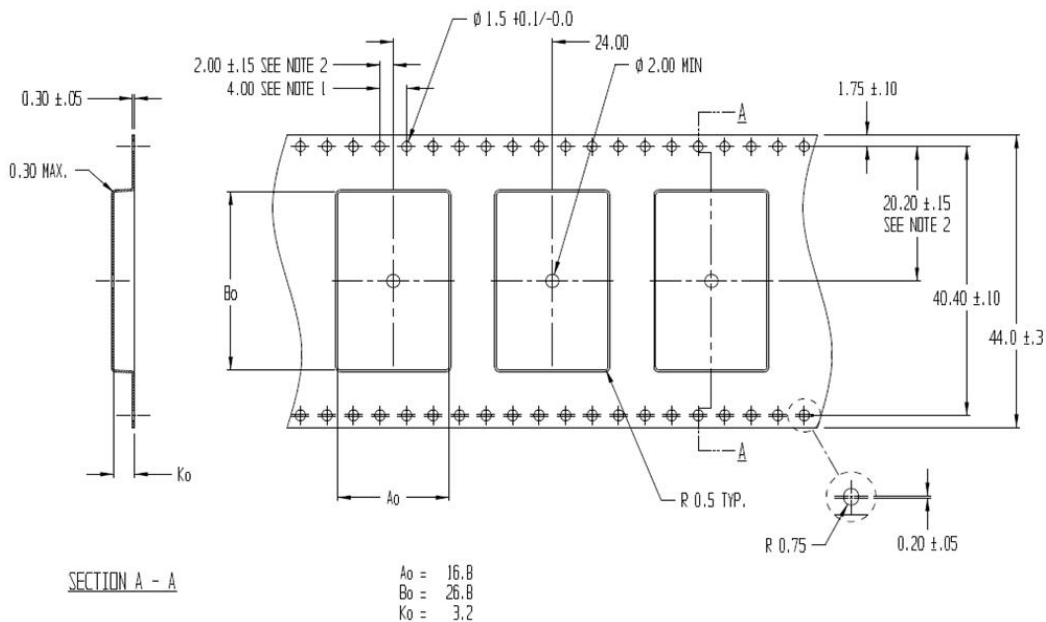



Figure 6: SARA-R4 series modules tape

Parameter	Typical value	Tolerance	Unit
A_0	16.8	0.2	mm
B_0	26.8	0.2	mm
K_0	3.2	0.2	mm

Table 31: SARA-R4 series tape dimensions (mm)

- Note 1: 10 sprocket hole pitch cumulative tolerance ± 0.2 mm.
- Note 2: pocket position relative to sprocket hole is measured as true position of pocket, not pocket hole.
- Note 3: A_0 and B_0 are calculated on a plane at a distance “R” above the bottom of the pocket.

7.2 Moisture Sensitivity Levels

-  SARA-R4 series modules are Moisture Sensitive Devices (MSD) in accordance to the IPC/JEDEC specification.

The Moisture Sensitivity Level (MSL) relates to the packaging and handling precautions required. SARA-R4 series modules are rated at MSL level 4. For more information regarding moisture sensitivity levels, labeling, storage and drying, see the u-blox package information user guide [3].

-  For the MSL standard, see IPC/JEDEC J-STD-020 (can be downloaded from www.jedec.org).

7.3 Reflow soldering

Reflow profiles are to be selected according to u-blox recommendations (see the SARA-R4 series system integration manual [2]).

-  Failure to observe these recommendations can result in severe damage to the device!

7.4 ESD precautions

-  SARA-R4 series modules contain highly sensitive electronic circuitry and are Electrostatic Sensitive Devices (ESD). Handling SARA-R4 series modules without proper ESD protection may destroy or damage them permanently.

SARA-R4 series modules are Electrostatic Sensitive Devices (ESD) and require special ESD precautions typically applied to ESD sensitive components.

[Table 7](#) details the maximum ESD ratings of the SARA-R4 series modules.

Proper ESD handling and packaging procedures must be applied throughout the processing, handling and operation of any application that incorporates the SARA-R4 series module.

ESD precautions should be implemented on the application board where the module is mounted, as described in the SARA-R4 series system integration manual [2].

-  Failure to observe these recommendations can result in severe damage to the device!

8 Labeling and ordering information

8.1 Product labeling

The labels of SARA-R4 series modules include important product information as described in this section. [Figure 7](#) illustrates the label of the SARA-R4 series modules, and includes: u-blox logo, production lot, Pb-free marking, product type number, IMEI number, certification information, and production country.

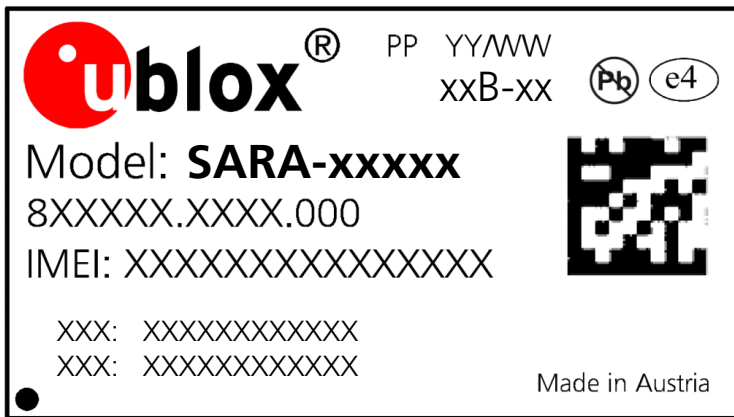

Figure 7: SARA-R4 series module label

8.2 Explanation of codes

Three different product code formats are used. The **Product Name** is used in documentation such as this data sheet and identifies all the u-blox products, independent of packaging and quality grade. The **Ordering Code** includes options and quality, while the **Type Number** includes the hardware and firmware versions. [Table 32](#) details these 3 different formats:

Format	Structure
Product Name	PPPP-TGVV(L)
Ordering Code	PPPP-TGVV(L)-MMQ
Type Number	PPPP-TGVV(L)-MMQ-XX

Table 32: Product code formats

[Table 33](#) explains the parts of the product code.

Code	Meaning	Example
PPPP	Form factor	SARA
TG	Platform (technology and generation) <ul style="list-style-type: none"> Dominant technology: G: GSM; U: HSUPA; C: CDMA 1xRTT; N: NB-IoT (LTE Cat NB1); R: LTE low data rate (Cat 1 and Cat M1); L: LTE high data rate (Cat 3 and above) Generation: 1...9 	R4
VV	Variant function set based on the same platform: 00...99	04
(L)	LTE category: 6,4,3,1,M ...	M
MM	Major product version: 00...99	00
Q	Product grade: B = professional, A = automotive	B
XX	Minor product version (not relevant for certification)	Default value is 00

Table 33: Part identification code

8.3 Ordering information

Ordering No.	Product
SARA-R404M-00B	LTE Cat M1 module Designed for operation in LTE band 13 26.0 x 16.0 mm, 250 pieces/reel
SARA-R410M-01B	LTE Cat M1 module Designed for operation in LTE bands 2, 4, 5, 12 26.0 x 16.0 mm, 250 pieces/reel
SARA-R410M-02B	LTE Cat M1 / NB1 module Designed for operation in LTE bands 2, 3, 4, 5, 8, 12, 13, 20, 25, 28 26.0 x 16.0 mm, 250 pieces/reel
SARA-R410M-52B	LTE Cat M1 module Designed for operation in LTE bands 2, 4, 5, 12, 13 26.0 x 16.0 mm, 250 pieces/reel
SARA-R410M-63B	LTE Cat M1 module Designed for operation in LTE bands 1, 8, 19 26.0 x 16.0 mm, 250 pieces/reel
SARA-R410M-73B	LTE Cat M1 module Designed for operation in LTE bands 3, 5, 26 26.0 x 16.0 mm, 250 pieces/reel
SARA-R412M-02B	LTE Cat M1 / NB1 and 2G module Designed for operation in LTE bands 2, 3, 4, 5, 8, 12, 13, 20 and 2G bands 850, 900, 1800, 1900 26.0 x 16.0 mm, 250 pieces/reel
SARA-N410-02B	LTE Cat NB1 module Designed for operation in LTE bands 2, 3, 4, 5, 8, 12, 13, 28 26.0 x 16.0 mm, 250 pieces/reel

Table 34: Product ordering codes

Appendix

A Glossary

Abbreviation	Definition
ADC	Analog to Digital Converter
DDC	Display Data Channel (I2C compatible) Interface
DL	Down-link (Reception)
DRX	Discontinuous Reception
eDRX	Extended Discontinuous Reception
ERS	External Reset Input Signal
ESD	Electrostatic Discharge
FCC	Federal Communication Commission (United States)
FDD	Frequency Division Duplex
FOAT	Firmware update Over AT commands
FOTA	Firmware update Over The Air
FW	Firmware
GCF	Global Certification Forum
GDI	Generic Digital Interfaces (power domain)
GITEKI	Gijutsu kijun tekigō shōmei - Japan technical standard conformity certification
GND	Ground
GPIO	General Purpose Input Output
GSMA	GSM Association
I	Input (means that this is an input port of the module)
I2C	Inter-Integrated Circuit Interface
I2S	Inter-Integrated circuit Sound Interface
IFT	Instituto Federal de Telecomunicaciones (Mexico)
IMEI	International Mobile Equipment Identity
ISED	Innovation, Science and Economic Development (Canada)
LGA	Land Grid Array
LPWA	Low Power Wide Area
LTE	Long Term Evolution
LWM2M	Open Mobile Alliance Lightweight Machine-to-Machine protocol
N/A	Not Applicable
NCC	National Communications Commission (Taiwan)
O	Output (means that this is an output port of the module)
OD	Open Drain
PCN	Product Change Notification / Sample Delivery Note / Information Note
POS	Power-On Input Signal
PSM	Power Saving Mode
PTCRB	PCS Type Certification Review Board
RCM	Regulatory Compliance Mark (Australia)
RED	Radio Equipment Directive (European Union)
RMC	Reference Measurement Channel
SDIO	Secure Digital Input Output
SIM	Subscriber Identity Module

Abbreviation	Definition
SPI	Serial Peripheral Interface
TBD	To Be Defined
TDD	Time Division Duplex
UART	Universal Asynchronous Receiver-Transmitter serial interface
UL	Up-link (Transmission)
USB	Universal Serial Bus
VoLTE	Voice over LTE

Table 35: Explanation of the abbreviations and terms used

Related documents

- [1] u-blox SARA-R4 series AT commands manual, doc. no. [UBX-17003787](#)
- [2] u-blox SARA-R4 series system integration manual, doc. no. [UBX-16029218](#)
- [3] u-blox package information user guide, doc. no. [UBX-14001652](#)
- [4] u-blox SARA-R4 series security suite application note, doc. no. [UBX-19030037](#)
- [5] 3GPP TS 27.007 - AT command set for User Equipment (UE)
- [6] 3GPP TS 27.005 - Use of Data Terminal Equipment - Data Circuit terminating Equipment (DTE - DCE) interface for Short Message Service (SMS) and Cell Broadcast Service (CBS)
- [7] 3GPP TS 27.010 - Terminal Equipment to User Equipment (TE-UE) multiplexer protocol
- [8] 3GPP TS 36.521-1 - Evolved Universal Terrestrial Radio Access; User Equipment conformance specification; Radio transmission and reception; part 1: conformance testing
- [9] 3GPP TS 51.010-1 - Mobile Station conformance specification; part 1: conformance specification
- [10] ITU-T Recommendation V24, 02-2000. List of definitions for interchange circuits between Data Terminal Equipment (DTE) and Data Connection Equipment (DCE)
- [11] Universal Serial Bus revision 2.0 specification, <https://www.usb.org/>
- [12] I2C-bus specification and user manual - UM10204 - NXP semiconductors, <https://www.nxp.com/docs/en/user-guide/UM10204.pdf>
- [13] IEC 60079-0 - Explosive atmospheres, part 0: equipment general requirements
- [14] IEC 60079-11 - Explosive atmospheres, part 11: equipment protection by intrinsic safety 'i'
- [15] IEC 60079-26 - Explosive atmospheres, part 26: equipment with EPL Ga

 For regular updates to u-blox documentation and to receive product change notifications, register on our homepage (www.u-blox.com).

Revision history

Revision	Date	Name	Comments
R01	07-Oct-2016	sfal	Initial release
R02	02-Feb-2017	sfal	Updated supported features and electrical characteristics
R03	05-May-2017	sfal / sses	Updated supported features and electrical characteristics Added the SARA-R410M-01B product version
R04	24-May-2017	sses	Updated supported features and electrical characteristics
R05	19-Jul-2017	sses	Updated supported features and electrical characteristics Extended document applicability to SARA-R410M-02B product version
R06	17-Aug-2017	sses	Updated supported features for "02" product version
R07	30-Oct-2017	sses	Updated SARA-R410M-01B product status Updated supported features for "02" product version
R08	04-Jan-2018	sses	Updated SARA-R410M-02B product status Updated USB, GPIO and other features description
R09	26-Feb-2018	sses	Updated SARA-R410M-02B product status Extended document applicability to SARA-R412M-02B product version Added Current consumption, Rx sensitivity and Thermal figures Updated UART MUX and Approvals info
R10	07-Mar-2018	mbab	u-blox rebranding. Updated SARA-R412M-02B modem and app version
R11	09-May-2018	sses	Updated SARA-R410M-02B product status Extended document applicability to SARA-N410-02B product version Updated UART and Approvals info
R12	10-Aug-2018	sses	Extended document applicability to SARA-R410M-52B product version Updated SARA-N410-02B and SARA-R412M-02B product status Clarified supported bands Added some current consumption figures
R13	20-Sep-2018	lpah	Extended document applicability to SARA-R404M-00B-01 type number Clarified mode supported in frequency bands
R14	12-Nov-2018	sses	Updated SARA-N410-02B product status Updated certification info
R15	15-Feb-2019	sses	Updated SARA-R412M-02B product status Revised supported bands Updated certification info Added current consumption figures Added parameters for ATEX applications Added orientation of modules on tape
R16	14-Jun-2019	sses	Extended document applicability to product versions SARA-R410M-02B-01, SARA-R410M-52B-01 and SARA-R412M-02B-01 Revised product description, approvals and other info according to extension of document applicability.
R17	27-Sep-2019	sses	Extended document applicability to product versions SARA-R410M-03B, SARA-R410M-63B, SARA-R410M-73B, and SARA-R412M-03B Updated product status of SARA-R410M-02B, SARA-R410M-52B, and SARA-N410-02B.
R18	20-Dec-2019	sses	Removed the document applicability to product versions SARA-R410M-03B, SARA-R412M-03B Updated product status of SARA-R410M-63B. Other minor corrections and clarifications.

Contact

For complete contact information, visit us at www.u-blox.com.

u-blox Offices

North, Central and South America

u-blox America, Inc.

Phone: +1 703 483 3180
E-mail: info_us@u-blox.com

Regional Office West Coast:

Phone: +1 408 573 3640
E-mail: info_us@u-blox.com

Technical Support:

Phone: +1 703 483 3185
E-mail: support@u-blox.com

Headquarters

Europe, Middle East, Africa

u-blox AG

Phone: +41 44 722 74 44
E-mail: info@u-blox.com
Support: support@u-blox.com

Asia, Australia, Pacific

u-blox Singapore Pte. Ltd.

Phone: +65 6734 3811
E-mail: info_ap@u-blox.com
Support: support_ap@u-blox.com

Regional Office Australia:

Phone: +61 2 8448 2016
E-mail: info_anz@u-blox.com
Support: support_ap@u-blox.com

Regional Office China (Beijing):

Phone: +86 10 68 133 545
E-mail: info_cn@u-blox.com
Support: support_cn@u-blox.com

Regional Office China (Chongqing):

Phone: +86 23 6815 1588
E-mail: info_cn@u-blox.com
Support: support_cn@u-blox.com

Regional Office China (Shanghai):

Phone: +86 21 6090 4832
E-mail: info_cn@u-blox.com
Support: support_cn@u-blox.com

Regional Office China (Shenzhen):

Phone: +86 755 8627 1083
E-mail: info_cn@u-blox.com
Support: support_cn@u-blox.com

Regional Office India:

Phone: +91 80 405 092 00
E-mail: info_in@u-blox.com
Support: support_in@u-blox.com

Regional Office Japan (Osaka):

Phone: +81 6 6941 3660
E-mail: info_jp@u-blox.com
Support: support_jp@u-blox.com

Regional Office Japan (Tokyo):

Phone: +81 3 5775 3850
E-mail: info_jp@u-blox.com
Support: support_jp@u-blox.com

Regional Office Korea:

Phone: +82 2 542 0861
E-mail: info_kr@u-blox.com
Support: support_kr@u-blox.com

Regional Office Taiwan:

Phone: +886 2 2657 1090
E-mail: info_tw@u-blox.com
Support: support_tw@u-blox.com